

VERSALIFT

torretta estraibile | concealed powerdock

SCHEDA TECNICA | DATA SHEET

ED.01_30.04.2024

VERSALIFT

torretta estraibile | concealed powerdock

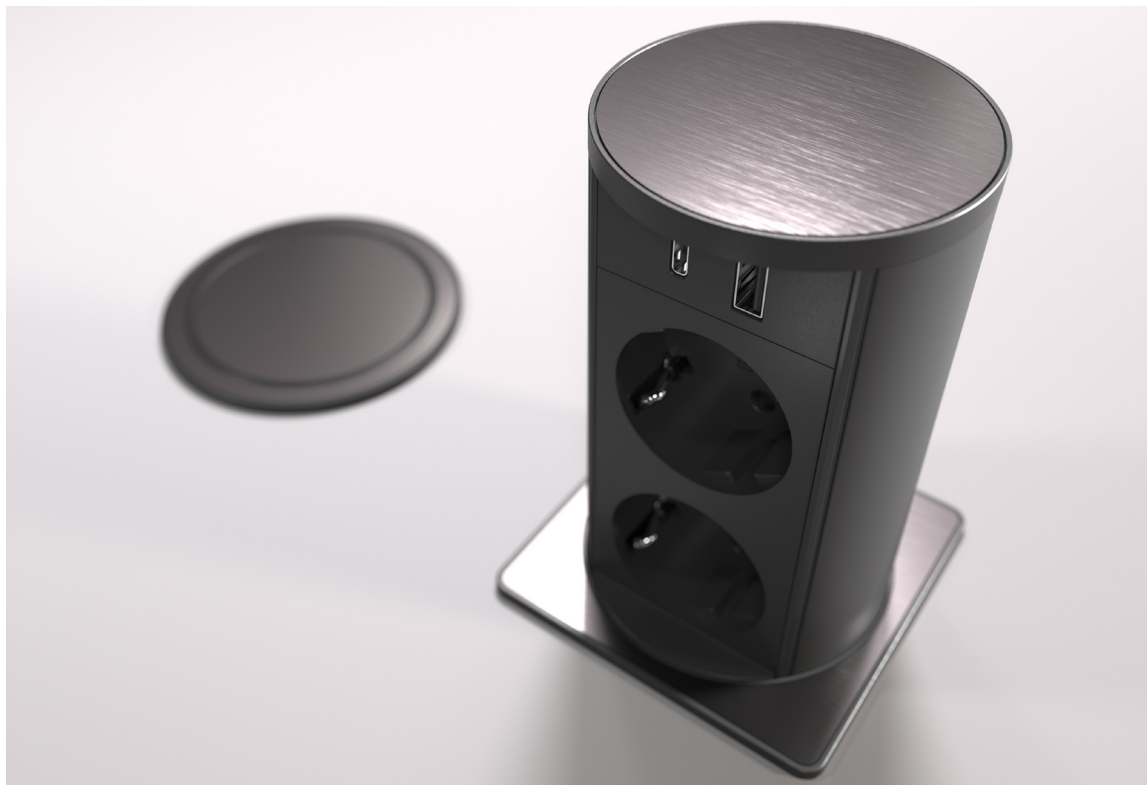

DATI COMMERCIALI | COMMERCIAL DATA

Codice prodotto

Product code

060.47

Codice famiglia di prodotto - Valido per tutte le configurazioni

Family product code - Valid for all configurations

DATI TECNICI | TECHNICAL DATA

GENERALE | GENERAL

Tensione nominale

Rated voltage

110 - 250 V ac, 50 Hz

Corrente nominale

Rated current

10 - 16A

Standard wireless di ricarica

Wireless charging standard

Qi

Grado di protezione

Degree of protection

IP54 Chiuso

IP54 Closed

IP20 Aperto

IP20 Open

Ambiente di utilizzo

Operating environment



Interno

Indoor

MATERIALI | MATERIALS

Profilo Profile	Alluminio anodizzato Anodized aluminium	
Componenti assemblaggio Assembly parts	Tecnopolimero autoestinguente Flame retardant polymer	
Prese elettriche Electric Sockets	Tecnopolimero autoestinguente Flame retardant polymer	
Finiture coperchio Cover finishes	Acciaio Stainless steel	Polimetilacrilato Methacrylate

PRESE ELETTRICHE | ELECTRIC SOCKETS

	E - F, 2P+T, con otturatori (protezione bimbi) E - F, 2P+T, with shutters (child protection)		
Tipo Type	 E  F		
Voltaggio Rated voltage	220 - 250 V ac, 50 Hz	Preso tipo Socket type	E - F
Corrente Rated current	16 A	Preso tipo Socket type	E - F
Carico massimo complessivo Max.load power	3400W	Preso tipo Socket type	E - F

PORTE USB DA RICARICA | USB CHARGING PORT

Ingresso Input	110 - 240 Vac 50/60 Hz		
Uscita Output	USB A+C	USB C: 5V 3A, max 18W (ricarica rapida / fast charging) USB A: 5V 3A, max 18W (ricarica rapida / fast charging) USB A+ USB C: 5V 3A (1.5+1.5) P.Max. 15W (ricarica normale / standard charging)	
	USB C	5V3A, 9V2A, 12V1.5A max 18W (ricarica rapida / fast charging)	
Compatibilità Compatibility	Tutti smartphone, tablet e altri dispositivi ricaricabili (fotocamere, auricolari, ecc.) All smartphones, tablets and other USB chargeable devices (cameras, headset etc.)		

POTENZA RICARICA WIRELESS INGRESSO | WIRELESS INPUT CHARGING POWER

Tensione Input voltage	100 - 240 Vac 50/60 Hz	
Corrente Input current	0.8A	
Assorbimento in standby Standby power Dissipation	<0.1W	

POTENZA RICARICA WIRELESS USCITA | WIRELESS OUTPUT CHARGING POWER

Tensione Input voltage	Max 5W (con USB in uso) Max 5W (with USB in use)	Max 10W (solo wireless charger) Max 10W (only wireless charger)
Compatibilità Compatibility	Tutti gli smartphone dotati di sistema di ricarica wireless All smartphones equipped with a wireless charging system	

FINITURE | FINISHES

Profilo | Profile



Nero
Black



Acciaio Satinato
Satin Steel

Coperchio | Top



Acciaio Spazzolato
Brushed Steel



Nero Spazzolato
Brushed black



Peltro
Pewter



Oro
Gold



Rame
Copper

Coperchio Wireless Charger | Wireless charger Top



Metacrilato nero
Black methacrylate



Metacrilato bianco
White methacrylate

CERTIFICAZIONI | APPROVALS



NOTE | NOTES

- Disponibili a richiesta altre finiture
- Uso solo in ambienti interni

ATTENZIONE!!!

- Questo apparecchio deve essere collegato a terra
- L'apparecchio deve essere collegato ad una presa principale correttamente installata e provvista di collegamento a terra in accordo alle norme vigenti.
- Se il prodotto viene montato in zone a rischio di contatto con l'acqua, è consigliato applicare del silicone o sigillanti simili sul piano dove appoggia la cornice.

- Indoor use only
- Other finishes available upon request

WARNING!!!

- This appliance must be earthed
- This appliance must be connected to a main socket correctly installed and provided with ground connection in accordance with current norms.
- If the product is mounted in areas at risk of contact with water, it is better to apply silicone or similar sealants on the panel where the frame stands.



RAEE - Rifiuti derivanti da Apparecchiature Elettriche ed Elettroniche. Questi prodotti devono essere riciclati in modo adeguato e non devono essere gettati fra i rifiuti domestici o nei rifiuti municipali indifferenziati.

WEEE - Waste of electric and electronic equipment. These products must be recycled properly and should not be disposed as household waste. Disposal in general household waste is prohibited.

Tutte le dimensioni indicate sono nominali. I disegni e le immagini sono solo a scopo illustrativo. I dettagli del prodotto e le dimensioni sono soggetti a modifiche senza preavviso.

All dimensions quoted are nominal only. Drawings and images are for illustrative purposes only. All product dimensions and specifications are subject to change without notice.

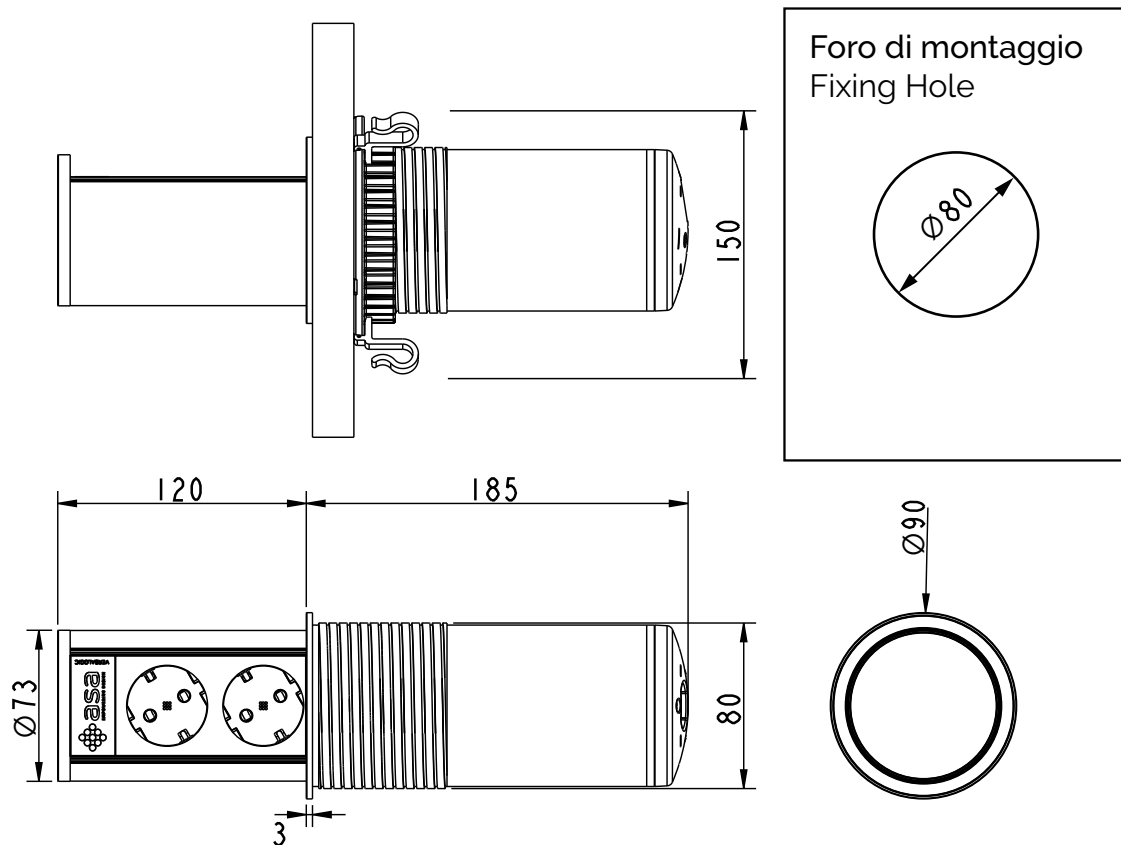
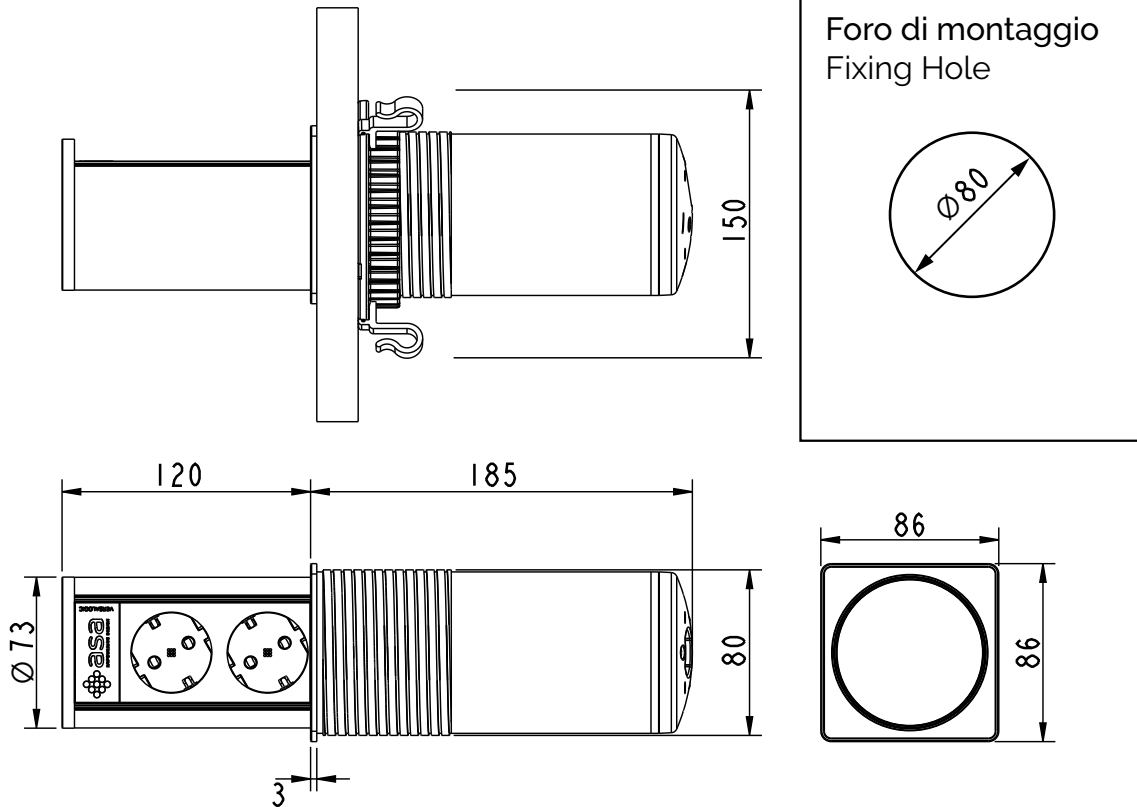









Asa Plastici srl
via Buonarroti, 58/60
20090 | Trezzano S/N (MI) | Italy
Tel/Phone +39 02 4455894 | Fax +39 02 4450107
web@asaplastici.it
asaplastici.com



VERSALIFT

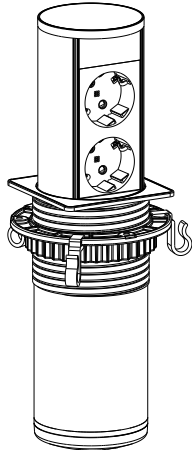
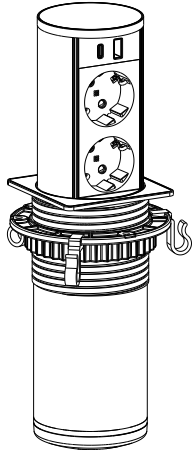







torretta estraibile
concealed powerdock





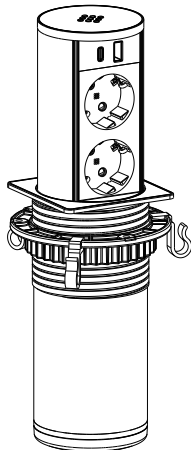

VERSALIFT versione quadra / square version					
PRESA SOCKET	 	F (SCHUKO)	 	E (FRENCH)	*
FINITURE COVER COVER FINISHES	2 FRUTTI POWER 2 POWER SOCKETS				
acciaio spazzolato stainless steel	060.47F.00001		060.47E.00001		
PREZZO PRICE					
nero spazzolato brushed black	060.47F.00002		060.47E.00002		
PREZZO PRICE					
oro gold	060.47F.00003		060.47E.00003		
PREZZO PRICE					
rame copper	060.47F.00004		060.47E.00004		
PREZZO PRICE					
peltro pewter	060.47F.00005		060.47E.00005		
PREZZO PRICE					
metacrilato nero black methacrylate	060.47F.00006		060.47E.00006		
PREZZO PRICE					
metacrilato bianco white methacrylate	060.47F.00007		060.47E.00007		
PREZZO PRICE					
FINITURE COVER COVER FINISHES	2 FRUTTO POWER + 1 USB 5V (2 PORTE A+C) 2 POWER SOCKET + 1 USB 5V (2PORTS A+C)				
acciaio spazzolato stainless steel	060.47F.00008		060.47E.00008		
PREZZO PRICE					
nero spazzolato brushed black	060.47F.00009		060.47E.00009		
PREZZO PRICE					
oro gold	060.47F.0010		060.47E.0010		
PREZZO PRICE					
rame copper	060.47F.00011		060.47E.00011		
PREZZO PRICE					
peltro pewter	060.47F.00012		060.47E.00012		
PREZZO PRICE					
metacrilato nero black methacrylate	060.47F.00013		060.47E.00013		
PREZZO PRICE					
metacrilato bianco white methacrylate	060.47F.00014		060.47E.00014		
PREZZO PRICE					
NOTE NOTES					
DIM. L x H x W 330 x 131 x 135 mm		PESO WEIGHT	PEZZI PER SCATOLA PCS PER BOX 1	MOQ 6 PZ / PCS	CODICE DOGANALE CUSTOM CODE 85366990
CAVI INCLUSI CABLES INCLUDED 2 metri / meters	 	* ORDINABILE DA GIUGNO - PRIMA CONSEGNA SETTEMBRE * SALES FROM JUNE - FIRST DELIVERY IN SEPTEMBER			





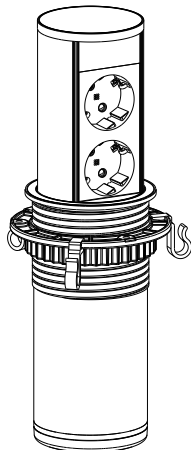



VERSALIFT

VERSALIFT versione quadra / square version

PRESA SOCKET	  F (SCHUKO)	  E (FRENCH)			
FINITURE COVER COVER FINISHES	2 FRUTTO POWER + 1 USB 5V (2 PORTE A+C) + WIRELESS CHARGER 2 POWER SOCKET + 1 USB 5V (2 PORTS A +C) + WIRELESS CHARGER				
metacrilato nero black methacrylate	060.47F.00015	060.47E.00015			
PREZZO PRICE					
metacrilato bianco white methacrylate	060.47F.00016	060.47E.00016			
PREZZO PRICE					
NOTE NOTES					
DIM. L x H x W 330 x 131 x 135 mm		PESO WEIGHT	PEZZI PER SCATOLA PCS PER BOX 1	MOQ 6 PZ / PCS	CODICE DOGANALE CUSTOM CODE 85366990
CAVI INCLUSI CABLES INCLUDED 2 metri / meters	 				

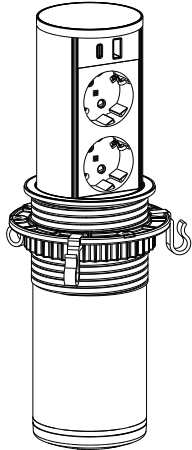
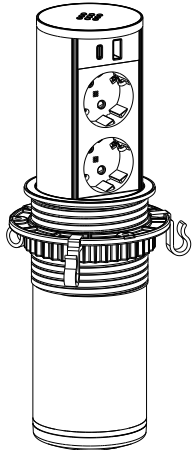
VERSALIFT versione tonda / round version

FINITURE COVER COVER FINISHES	2 FRUTTI POWER 2 POWER SOCKETS				
acciaio spazzolato stainless steel	060.47F.00101	060.47E.00101			
PREZZO PRICE					
nero spazzolato brushed black	060.47F.00102	060.47E.00102			
PREZZO PRICE					
oro gold	060.47F.00103	060.47E.00103			
PREZZO PRICE					
rame copper	060.47F.00104	060.47E.00104			
PREZZO PRICE					
peltro pewter	060.47F.00105	060.47E.00105			
PREZZO PRICE					
metacrilato nero black methacrylate	060.47F.00106	060.47E.00106			
PREZZO PRICE					
metacrilato bianco white methacrylate	060.47F.00107	060.47E.00107			
PREZZO PRICE					
NOTE NOTES					
DIM. L x H x W 330 x 131 x 135 mm		PESO WEIGHT	PEZZI PER SCATOLA PCS PER BOX 1	MOQ 6 PZ / PCS	CODICE DOGANALE CUSTOM CODE 85366990
CAVI INCLUSI CABLES INCLUDED 2 metri / meters	 				

VERSALIFT versione tonda / round version					
PRESA SOCKET	 	F (SCHUKO)	 	E (FRENCH)	
FINITURE COVER COVER FINISHES	2 FRUTTO POWER + 1 USB 5V (2 PORTE A+C) 2 POWER SOCKET + 1 USB 5V (2PORTS A+C)				
acciaio spazzolato stainless steel	060.47F.00108		060.47E.00108		
PREZZO PRICE					
nero spazzolato brushed black	060.47F.00109		060.47E.00109		
PREZZO PRICE					
oro gold	060.47F.00110		060.47E.00110		
PREZZO PRICE					
rame copper	060.47F.00111		060.47E.00111		
PREZZO PRICE					
peltro pewter	060.47F.00112		060.47E.00112		
PREZZO PRICE					
metacrilato nero black methacrylate	060.47F.00113		060.47E.00113		
PREZZO PRICE					
metacrilato bianco white methacrylate	060.47F.00114		060.47E.00114		
PREZZO PRICE					
FINITURE COVER COVER FINISHES	2 FRUTTO POWER + 1 USB 5V (2 PORTE A+C) + WIRELESS CHARGER 2 POWER SOCKET + 1 USB 5V (2 PORTS A +C) + WIRELESS CHARGER				
metacrilato nero black methacrylate	060.47F.00115		060.47E.00115		
PREZZO PRICE					
metacrilato bianco white methacrylate	060.47F.00116		060.47E.00116		
PREZZO PRICE					
NOTE NOTES					
DIM. L x H x W 330 x 131 x 135 mm		PESO WEIGHT	PEZZI PER SCATOLA PCS PER BOX 1	MOQ 6 PZ / PCS	CODICE DOGANALE CUSTOM CODE 85366990
CAVI INCLUSI CABLES INCLUDED 2 metri / meters	 				

VERSALIFT